

36kV Cold Shrinkable Termination INSTALLATION For Single-Core Cable

DESCRIPTION

The Chardon Cold Shrinkable Termination offers easy installation and reliable performance when terminating indoor and outdoor medium voltage cables. Made from high quality, UV resistant, silicone rubber, the Chardon Cold Shrinkable termination offers a combination of durability and high performance in the field. The Chardon Cold Shrinkable Terminations include a stress controlling compound housing, preassembled on a plastic “hold out” tube. As the plastic hold out is removed, the stress-relief housing shrinks onto the cable. Chardon terminations are easy to install, and have a wide application range. No tools or heat sources are required. The products are designed to last the entire life of the cable.

The Chardon Cold Shrinkable terminations are tested according to IEC 60502-4 standard .



ORDERING INSTRUCTIONS:

Standard Voltage Class	Part Number	Cable Insulation O.D. Range
36kV	36-CSTO -A	15.2~22.4
	36-CSTO -B	20.4~35.4
	36-CSTO -C	34.0~60.0

COLD SHRINKABLE TERMINATION KIT CONTENT:

- - Cold Shrinkable Termination
- - Paper towel
- - Silicone lubricant
- - Sealing tape
- - PVC tape(Black)
- - Silicone tape
- - Copper tape
- - Sandpaper belt
- - Gloves
- - Installation & Operating instructions
- - Cable lug (Optional)
- - Grounding kit (Optional)



CAUTION: All associated apparatus must be de-energized during installation and/or maintenance.



DANGER: Do not touch or move energized product by hand. Failure to follow this instruction may result in serious or fatal injury, as well as damage to the product.

SAFETY INFORMATION

The instructions in this manual are not intended as a substitute for proper training or adequate experience in the safe operation of the equipment described. Only competent technicians, who are familiar with this equipment should install, operate and service it.

Chardon Cold Shrinkable Termination for Single Conductor Tape Shielded , Wire Shielded or Jacketed Concentric Neutral (JCN) Cable

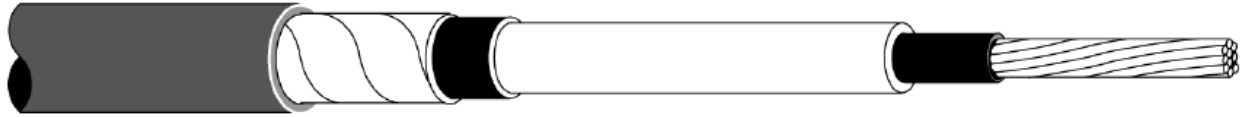

Tape Shielded Cable



Wire Shielded Cable



Jacketed Concentric Neutral (JCN) Cable

INSTALL PROCEDURE

A. Prepare Cable

**Tape Shielded Cable
(Only this cable can use the
grounding kit.)**

STEP 1

● Prepare cable using dimensions as shown in Fig.1 .

NOTE: Ensure that all parts of the cable are not damaged. If there is any irreparable damage, a new cable needs to be made .If there is any impurity or slight damage on the surface of the insulation, it can be polished with fine sandpaper.

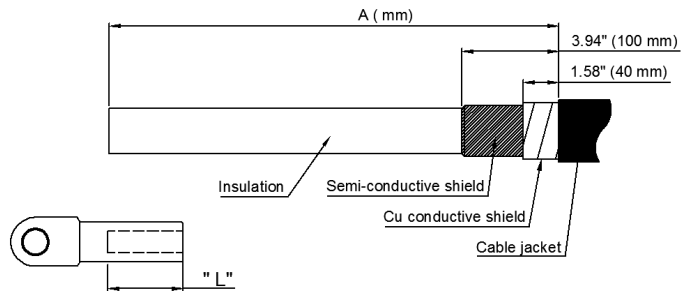

Fig.1

Part Number	36-A	36-B	36-C
Cable Insulation O.D. Range	15.2~22.4	20.4~35.4	34.0~60.0
A (mm)	360+L	370+L	375+L
"L" refers to the hole depth of the connector			

STEP 2

- Sand off the sharp corners of the Cu conductive shield with coarse sandpaper and secure with copper tape.
- Use coarse sandpaper to grind the cable jacket about 30mm to rough the surface.
- Clean cable jacket and Wrap 1 circle of sealing tape in the polished area of the cable sheath.
- Measure down 25mm from top of the cable jacket use constant-force spring to fix ground braid onto Cu conductive shield.

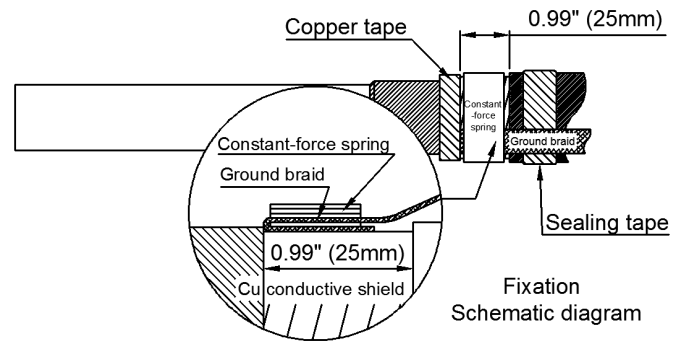
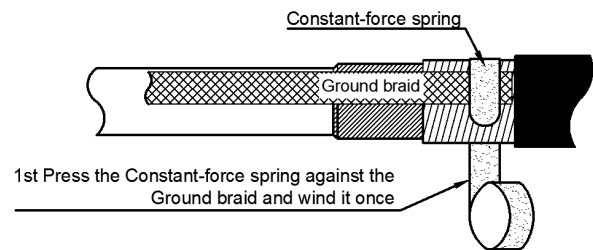

Fig.2

Constant-force spring installation instructions

- 1st Press the Constant-force spring against the Ground braid and wind it once.
- 2nd Bend Ground braid down and parallel to cable.
- 3rd Wind the remaining Constant-force spring until the installation is complete



1st Press the Constant-force spring against the Ground braid and wind it once

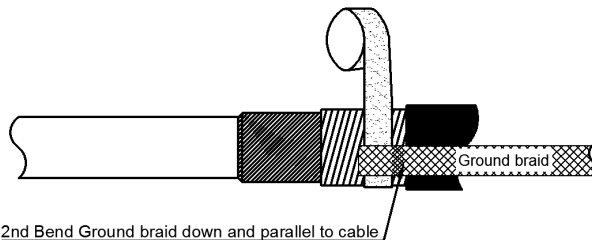

2nd Bend Ground braid down and parallel to cable

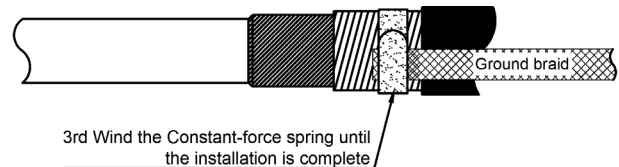

3rd Wind the Constant-force spring until the installation is complete

STEP 3

- Measure down 85mm from top of the Cu conductive shield wrap the sealing tape onto the ground braid.
- The height of the tape is 5mm (min) higher than that of the cable jacket.
- Wrap the PVC tape on top of it by 4 laps.
- Proceed to step B.

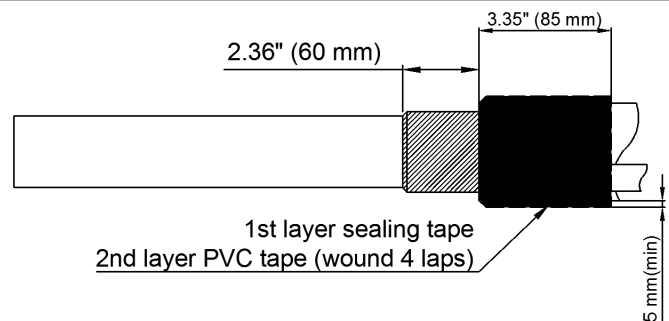

Fig.3

Wire Shielded Cable / JNC Cable

STEP 1

- Measure down from top of the cable as shown in Fig.4 . Remove cable jacket (if jacketed cable is used) to expose neutral wires.
- Use copper wire to lash the neutral wires. Use coarse sandpaper to grind the cable jacket about 25mm to rough the surface.
- Clean cable jacket and Neutral wires.
- Wrap 1 circle of sealing tape in the polished area of the cable sheath.

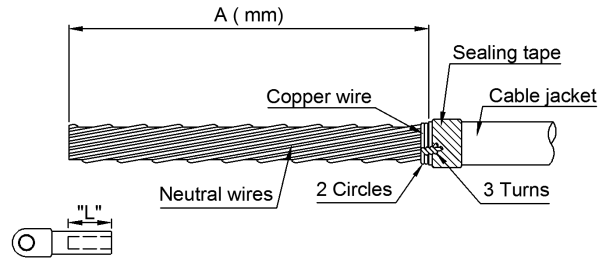

Fig.4

Part Number	36-A	36-B	36-C
Cable Insulation O.D. Range	15.2~22.4	20.4~35.4	34.0~60.0
A (mm)	340+L	350+L	355+L
"L" refers to the hole depth of the connector			

STEP 2

- Bend neutral wires down and parallel to cable.
- Use copper wire to secure neutral wires to cable jacket as shown in Fig.5.

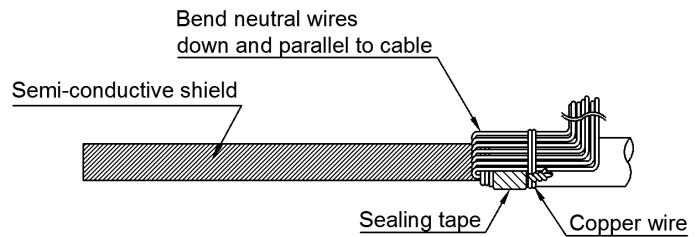

Fig.5

STEP 3

- Keep the 60mm semi-conductive shield and remove excess .
- Measure down 85mm from top of the neutral wires wrap the sealing tape.
- The height of the tape is 5mm (min) higher than that of the cable jacket.
- Wrap the PVC tape on top of it by 4 laps.

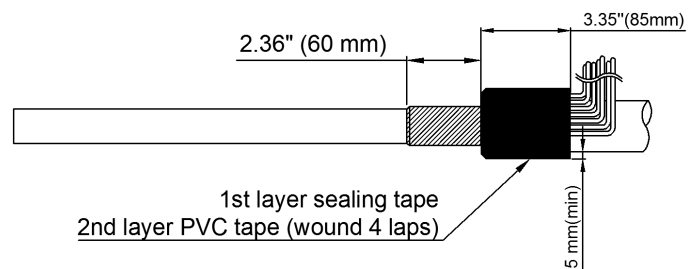

Fig.6

Proceed to step B.

NOTE: Ensure that all parts of the cable are not damaged. If there is any irreparable damage, a new cable needs to be made .If there is any impurity or slight damage on the surface of the insulation , it can be polished with fine sandpaper.

B. Install Termination

STEP 1

- Polish and clean thoroughly the insulation by using sandpaper belt and paper towel then apply the silicone lubricant around the dotted line area.

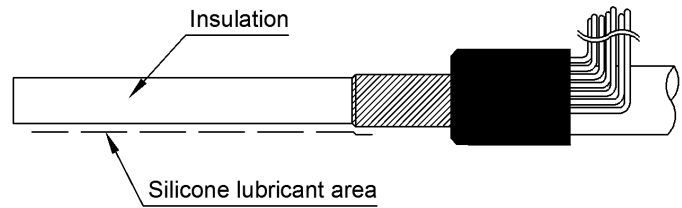

Fig.7

STEP 2

- Mark insulation shield for 60mm on the PVC tape
- Place the cold shrink termination onto the cable, aligning the mark with the end of the hold out tube. Take out the hold out tube to complete the installation.

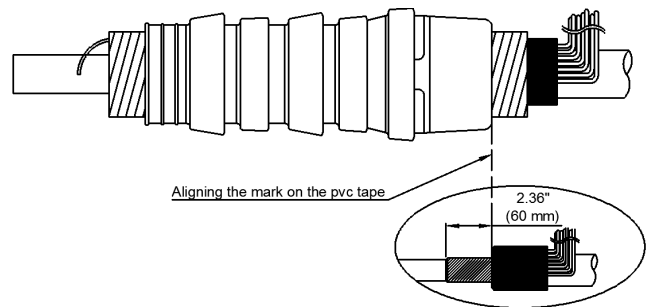

Fig.8

STEP 3

- Apply silicone lubricant to skirt and PVC area.

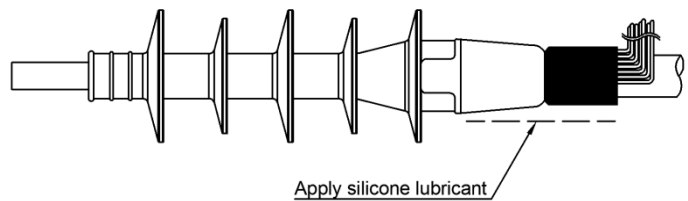

Fig.9

STEP 4

- Pull down the skirt over the PVC tape to seal the cable entrance.

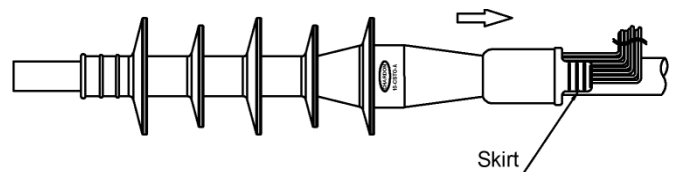

Fig.10

C. Install Compression Connector

STEP 1

- Keep the "L+0.39"(10mm)" insulation and remove the excess part.
- Remove the insulation to expose the bare conductor according to lug depth "L" as shown in Fig.11.

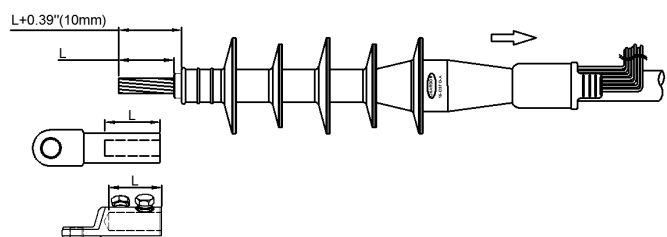

Fig.11

STEP 2

- Clean the exposed conductor by using a wire brush.
- Place the connector on the exposed conductor and Install it.

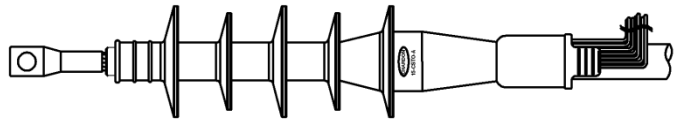

Fig.12

STEP 3

- Wrap the sealing tape between the insulation and connector.

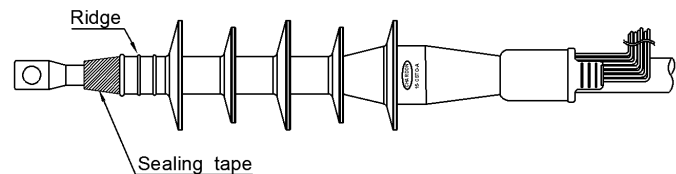

Fig.13

STEP 4

- Seal the top of the terminator at the connector area with Silicone tape.

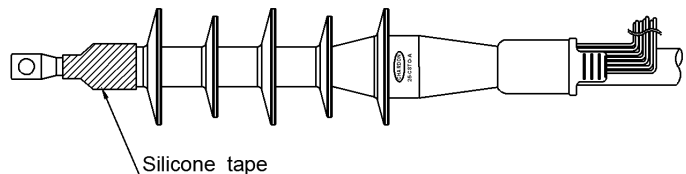

Fig.14

In as much as CHARDON GROUP, Inc. has no control over the use which others may put the material, it does not guarantee that the same results as those described herein will be obtained, Each user of the material should make his own tests to determine the material's suitability for his own particular use. Statements concerning possible uses of the materials described herein are not to be construed as constituting a license under any CHARDON GROUP, inc. patent covering such use or as recommendations for use of such materials in the infringement of any patent.

FOR FURTHER INFORMATION WRITE TO



sales@chardongroup.com