

200A, 15 kV Class Loadbreak Rotatable Feed Thru Insert



APPLICATION

The Chardon Loadbreak Feed Thru Insert threads onto a standard 200A bushing well and provides dual loadbreak bushing interfaces. It can convert radial-feed transformers to feedthru transformers and add in-line arrester protection if needed. The torque limit ratchet feature prevents the bushing well stud from breaking during installation. The ratchet feature allows users to rotate the feed thru insert for 360° to orient the feedthru insert in the desired position.

The Chardon Loadbreak Feed Thru Insert meets all the requirements of IEEE Standard 386, and is fully interchangeable with competitor's products and mating products that also meet IEEE Standard 386. When installed with mating components, the bushing insert provides a fully shielded and fully submersible connection for loadbreak applications.

PRODUCTION TESTS

Tests conducted in accordance with IEEE/ANSI Standard 386.

- Minimum Corona Voltage Level – 11 kV
- AC 1 Minute Withstand – 34 kV

Tests conducted in accordance with Chardon manufacturing process requirements:

- Physical Inspection
- Periodic Dissection
- Periodic X-ray Analysis

VOLTAGE RATINGS

Voltage Class	15 kV
Max. Rating Phase to Phase	14.4 kV
Max. Rating Phase to Ground	8.3 kV
AC 1 Minute Withstand	34 kV
DC 15 Minute Withstand	53 kV
BIL and Full Wave Crest	95 kV
Minimum Corona Voltage Level	11 kV

• 15-LFTI200-030623-REV03

CURRENT RATINGS

Description	Test Parameters
Continuous	200 amps rms
Switching	10 operations at 200 amps rms at 14.4 kV
Fault Close	10,000 amps rms symmetrical at 14.4 kV for 0.17 s after 10 consecutive successful switching operations
Short Time	• 10,000 amps rms symmetrical for 0.17 s • 3,500 amps rms symmetrical for 3.0 s

DETAILED COMPOSITION OF THE CHARDON LOADBREAK FEED THRU INSERT

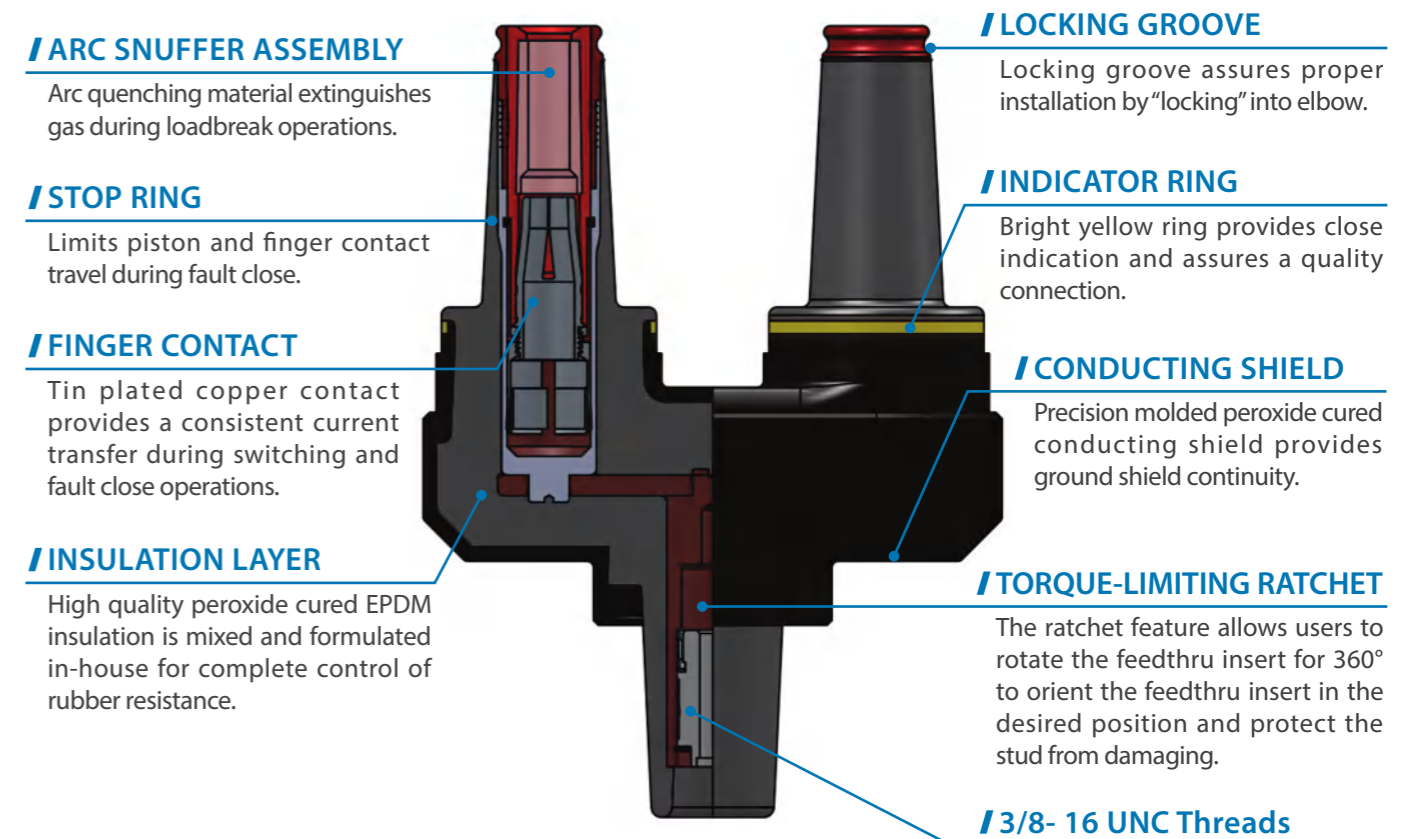

ORDERING INFORMATION

15kV,200A Loadbreak Feed Thru Insert 15-LFTI

Each kit contains:

- Rotatable Feed Thru Insert
- Shipping Cap (not for energized operation)
- Stainless Steel Bail Assembly
- Silicone Lubricant
- Installation Instruction Sheet

Replacement Part

Bail Assembly 15-BAIL-LFTI

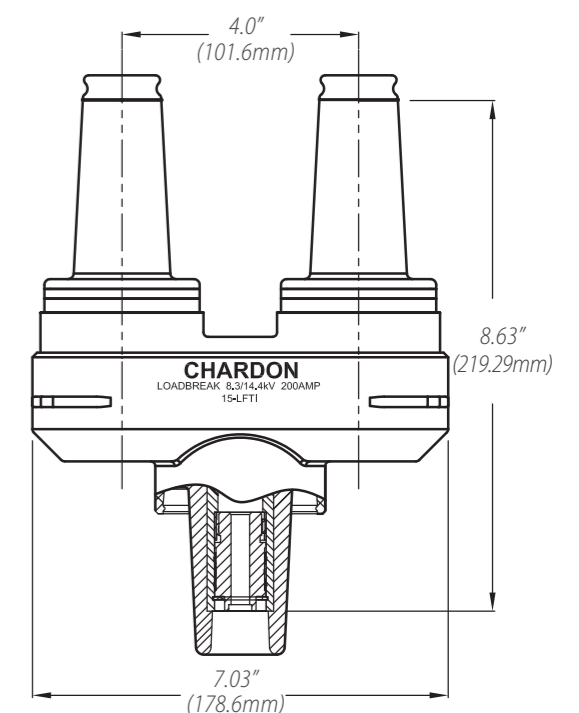



CHARDON TAIWAN CORPORATION

No.37 Min-Chie Road, Tung Lo
Industrial Park, Miao Li, Taiwan 366

Tel : +886-37-984385

Fax : +886-37-984770

www.chardongroup.com • info@chardongroup.com